



architectural

UT Spot 3.5" Track

Track Mounted Directional Accent

Description

The UT Spot is a family of high output indoor track lights suitable for any application, from museum exhibitions to commercial premises and offices or residential environments. Available up to 3000 lumens each, the UT Spot is line voltage and houses its driver in a discreet small box that integrates with the track, giving it a sleek modern look.

Lamps

- LED: Bridgelux
20W, 1800lm, 3000k, CRI 90
33W, 3000lm, 3000k, CRI 90
33W, 3000lm, 3000k, CRI 80
33W, 3000lm, 2700k, CRI 80
33W, 3000lm, 2700k, CRI 80

Construction

- Fixture body is high pressure injected aluminum
- All optics are made of aluminium with specular finish

Notes

- Maximum tilt angle 90°
- Maximum rotation 365°
- Beam spreads available in 17°, 23° and 32°
- Track head wattage is model dependant

Electrical

- Fixture is constant current, low voltage LED with integral power supply
- Track heads are designed for use with standard three circuit track
- Fixture is 20 watts, 33 watts.

Photometrics

For current IES files please visit usa.flos.com

Warranty

2 years from date of sale

Fixture Type

Job Name

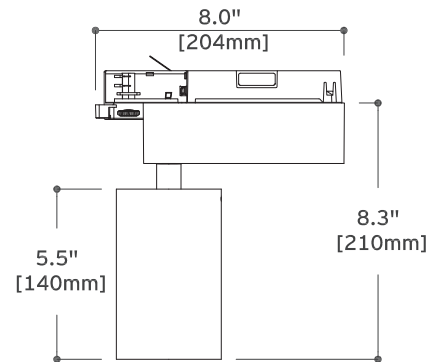
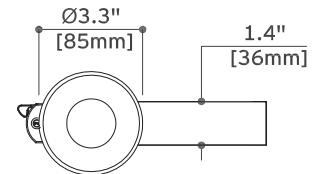
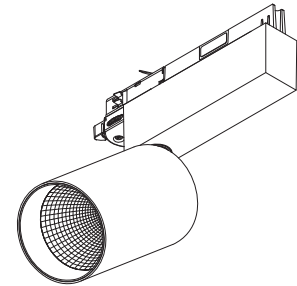



architectural

UT Spot 3.5" Track

Track Mounted Directional Accent





Fixture Type

Job Name

How to Specify ex. 09.4213.30.A90

QTY	Item Number	Description	Finish	Beam Angle	Power Supply
	09.4213	UT Spot Track Spotlight, 20W, 1800lm, 3000k, CRI 90	<input type="checkbox"/> 14 = Black <input type="checkbox"/> 30 = White	17	
	09.4200		<input type="checkbox"/> 14 = Black <input type="checkbox"/> 30 = White	17	
	09.4201	UT Spot Track Spotlight, 33W, 3000lm, 3000k, CRI 80	<input type="checkbox"/> 14 = Black <input type="checkbox"/> 30 = White	23	
	09.4202		<input type="checkbox"/> 14 = Black <input type="checkbox"/> 30 = White	32	
	09.4203		<input type="checkbox"/> 14 = Black <input type="checkbox"/> 30 = White	17	
	09.4205	UT Spot Track Spotlight, 33W, 3000lm, 2700k, CRI 80	<input type="checkbox"/> 14 = Black <input type="checkbox"/> 30 = White	23	A90 = No dimmable, 120-277V
	09.4204		<input type="checkbox"/> 14 = Black <input type="checkbox"/> 30 = White	23	
	09.4211		<input type="checkbox"/> 14 = Black <input type="checkbox"/> 30 = White	23	
	09.4212	UT Spot Track Spotlight, 33W, 3000lm, 3000k, CRI 90	<input type="checkbox"/> 14 = Black <input type="checkbox"/> 30 = White	32	
	09.4210		<input type="checkbox"/> 14 = Black <input type="checkbox"/> 30 = White	17	

Optional Accessories

Image	QTY	Item Number	Description
		08.8410.00	Holding ring
		08.8411.00	Cross baffle
		08.8163.68	Elliptical lens
		08.8175.68	Flood lens
		08.8495.14	Honeycomb anti-glare louvre





architectural









UT Spot 3.5" Track

Track Mounted Directional Accent

Fixture Type

Job Name

Optional Accessories (cont'd)

Image	QTY	Item Number	Description
		08.8160.0D	Blue filter
		08.8160.DL	Daylight filter
		08.8160.66.0D	Amber filter
		08.8160.67.0D	Red filter
		08.8160.98.0D	UV filter
		08.8160.68	IR filter
		08.8160.69	Hot light filter
		08.8160.ND	Neodymium filter

Track

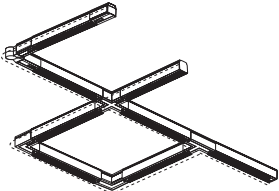
Image	Description
	Contact FLOS sales agent for configuration of layout and specification information

