

Light Supply Fixed, Trimmed

Ceiling Recessed Fixed Downlight

Fixture Type

Job Name

Description

A range of compact LED downlights capable of up to 3000 lm output, specially designed for public spaces and retail installations. Offering a wide range of options, optics and accessories, the Light Supply is available in fixed, wall-washer and adjustable versions, as well as trimmed and trimless, making a complete family that can be used throughout a project for many different lighting needs.

Lamps

- LED: Xicato
26W, 2280lm, 3000K, CRI 98, 50°
28W, 3000lm, 3000K, CRI 80, 50°
28W, 3000lm, 4000K, CRI 80, 50°

Notes

- Fixture comes with separate trimless installation frame which allows for installation in sheet rock and special construction ceilings up to 1/2" thick
- Trimless versions must be mounted in a standard pre-installation metal frame (shipped separately with product) or in a Soft Architecture technology installation frame for 1/2" thick ceilings
- Spot, medium and flood reflectors are available as accessories to change the light beam angle
- 10.9" (277mm) minimum plenum height
- Housing details available upon request
- Listings: UL Listed, IP44 damp location

Electrical

- Fixture is constant current, low voltage 26 or 28W LED (integral)
- Available with splice box, containing 0-10 volt dimmable constant current driver.

Construction

- The Fixed Trim version is available with external ring black or white combined with internal white or chrome reflector.
- Injection molded specular reflector with a matte finish.
- Die cast aluminum lamp body.
- Accessories include: pre-installation frame or Soft Architecture installation plate. Available finishes: white (40) and black (14)

Photometrics

For current IES files please visit flosusa.com

Warranty

2 years from date of sale

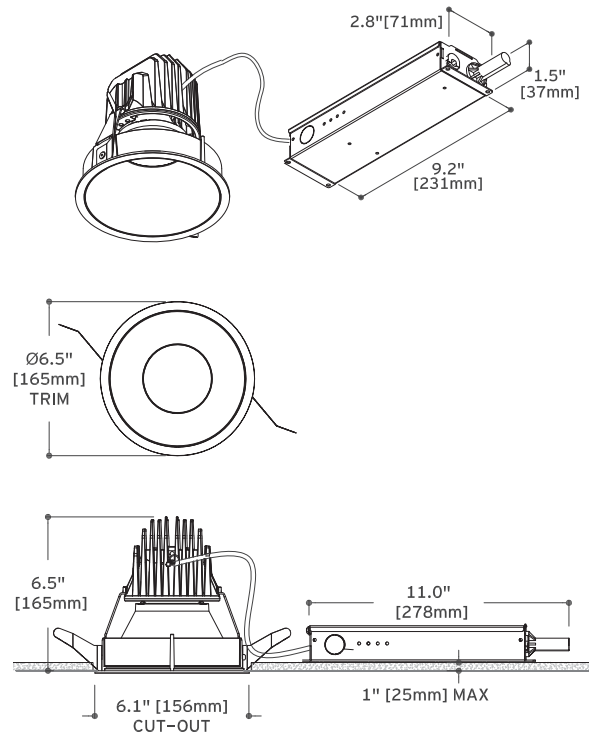

How to Specify ex. 03.6611.3C.90

QTY	Item Number	Description	Finish (Trim/Reflector)	Power Supply
	03.6611	Light Supply Fixed Trimmed, LED, 26W, 2280lm, 3000K, CRI 98	<input type="checkbox"/> 1B = Black/White <input type="checkbox"/> 1C = Black/Aluminum <input type="checkbox"/> 3B = White/White <input type="checkbox"/> 3C = White/Aluminum	90 = Housing with LED driver 830mA, ELV, 120V UL = Splice box, 1% dim, 0-10V, 120V 7U = Splice box, 1% dim, 0-10V, 277V GT = Splice box, 10% dim, ELV, 120V
	03.6609	Light Supply Fixed Trimmed, LED, 28W, 3000lm, 3000K, CRI 80	<input type="checkbox"/> 1B = Black/White <input type="checkbox"/> 1C = Black/Aluminum <input type="checkbox"/> 3B = White/White <input type="checkbox"/> 3C = White/Aluminum	90 = Housing with LED driver 1000mA, non-dimmable, 120V UL = Splice box, 1% dim, 0-10V, 120V 7U = Splice box, 1% dim, 0-10V, 277V GT = Splice box, 10% dim, ELV, 120V
	03.6610	Light Supply Fixed Trimmed, LED, 28W, 3000lm, 4000K, CRI 80	<input type="checkbox"/> 1B = Black/White <input type="checkbox"/> 1C = Black/Aluminum <input type="checkbox"/> 3B = White/White <input type="checkbox"/> 3C = White/Aluminum	90 = Housing with LED driver 1000mA, non-dimmable, 120V UL = Splice box, 1% dim, 0-10V, 120V 7U = Splice box, 1% dim, 0-10V, 277V GT = Splice box, 10% dim, ELV, 120V



architectural







Light Supply Fixed, Trimmed

Ceiling Recessed Fixed Downlight

Fixture Type

Job Name

Optional Accessories

Image	QTY	Item Number	Description
		08.8118.68	Elliptical lens
		08.8177.68	Flood lens
		08.8242.14	Black painted aluminium cross baffle
		08.8049.14	Honeycomb anti-glare louvre (small cells)
		08.8377.14	Honeycomb anti-glare louvre (big cells)
		SA.6600.01	Soft Architecture installation frame for 1/2" thick ceilings

