

Battery 3L Trimmed

Ceiling Recessed Downlight

Description

1, 2 or 3 lamp adjustable system, for recessed ceiling thicknesses up to 30mm (1.2"). Suitable for use with LED lamps capable up to 2290lm output per point of light. The Battery family is available in trimmed and trimless options.

Lamps

LED : Bridgelux
3x 16.5W, 3x 2159lm, 3000K, CR180

Notes

Maximum tilt angle 40°
Beam spreads available in 29° and 44°
Optional filters to be ordered separately
Listings: UL Listed, IP20

Installation frame ordered separately, when ordering registration tray the installation frame is included

Warranty

2 years from date of sale.

Photometrics

For current IES files please visit
architectural.flosusa.com

Finish

20 White 08 Mercury 14 Black



Construction

Pressed steel and matte black, powder-coated recessed housing

Innovative steel bracket fixing system, painted black, with allen key locking mechanism

Electrical

Fixture is constant current, low voltage
16.5W per head

LED included non replaceable





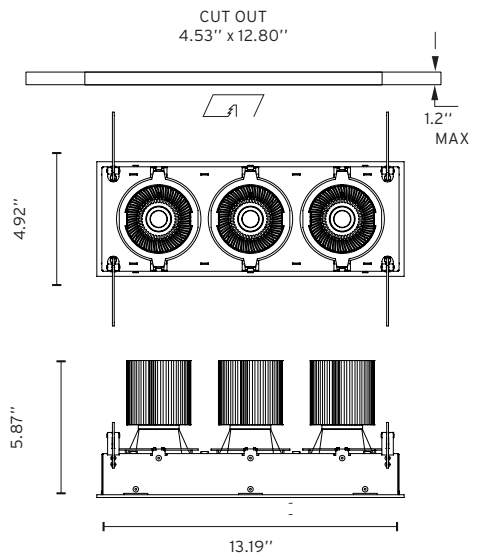
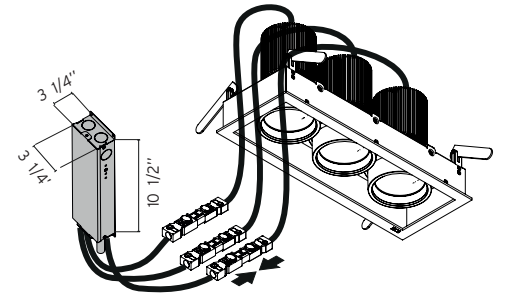



Ceiling mounted driver/splice box contains
dimmable 0-10V driver standard

Consult factory for housing option



Battery 3L Trimmed
Ceiling Recessed Downlight

Optional Accesories

Image	QTY	Item Number	Description
		08.8495.14	Honeycomb
		08.8503.64.OD	Blue Filter
		08.8503.65.OD	Sky Blue Filter
		08.8503.66.OD	Amber Filter
		08.8503.67.OD	Red Filter
		08.8503.69	Hot Light
		08.8503.CL	Old light
		08.8503.DL	Daylight
		08.8503.ND	Neodinium